

FUKKO Radial Vane Pump

RADIAL VANE PUMP



Both high-viscosity liquids and foamy liquids are supported.

FUKKO Radial Vane Pump

Completely self-priming type Supports severe working conditions for your order



FUKKO's radial vane pump is a so-called volume type pump that repeats suction and discharge with changes in volume. Multiple vanes (movable impellers) are attached to the rotor in a radial way. Since the rotor is positioned eccentrically with the pump casing, the volume of the space formed by two vanes and casing along with rotation repeatedly enlarges and reduces its volume. This continuous action makes the liquid (fluid) to be sucked and discharged and allows the operation to be started without need for priming. Irrespective of the liquid type (both high viscosity or foamy liquids are acceptable), it permits low-speed operation and it can smoothly adjust the amount of discharge. It is also suited for transferring of liquids that must not be stirred.

● Main specifications

Model	V type , R type
Aperture	20A to 80A
Whole lifting	0.5 MPa at maximum
Discharge volume	700 L/min at maximum
Driving type	Direct-coupled, V-belt driven type

Main applications and target fluids to be transferred suited for the pump

- Lifting of low- or high-viscosity liquids from a drum
- Recollection of floating oil
- Withdrawal from a vacuum tank

Chemical industries

Chemicals, dyes, inks, pastes, adhesives, acetone, toluene, MEK, waste oil, latex

Food industries

Soybean milk, yeast, unrefined sake, liquid sugar, miso (soy paste), ketchup, mayonnaise, chocolate, cake raw liquid, fine sweet paste

Chemicals and cosmetics

Shampoos, milky lotions, cleaners, creams, soaps

Oil, paints, oil fats

Crude petroleum, jet fuel, gasoline, kerosene, various solvents, grease, water-soluble wax, resin paint

Environmental equipment, water treatment

Sludge, high-molecular coagulants, lime solutions, raw solvents, various waste liquids

The operation principle of Radial Vane

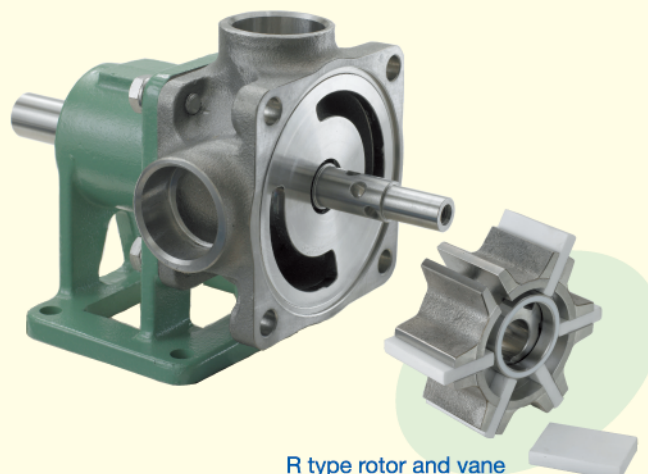

Suction start
(volume=small)

Suction end
(volume=large)

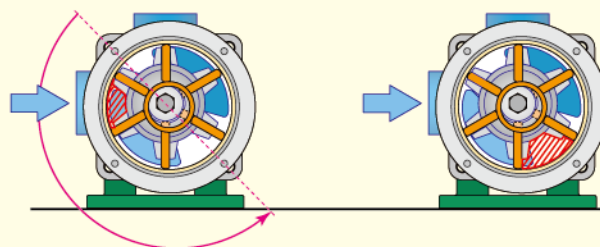

The volume begins to be expanded.

The volume becomes the maximum.

No liquid is left even at the bottom of a drum

R type and V type

Two types of FUKKO's radial vane pumps are available: the R type that have sold 60,000 pumps for thirty years, and the V type that has realized improved performance.

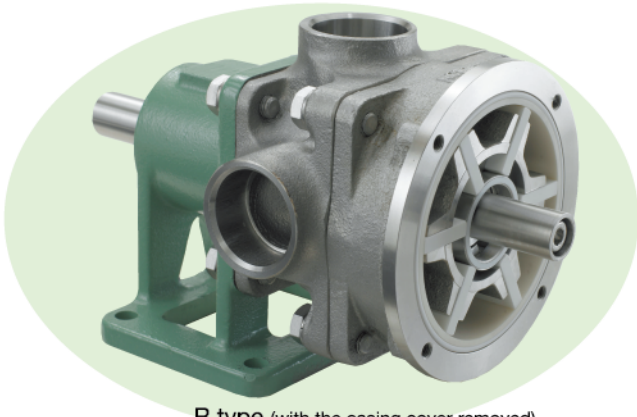

R type (with the casing cover removed)

R type

- Operating a single switch allows liquid to be transferred in either a clockwise or counterclockwise direction.

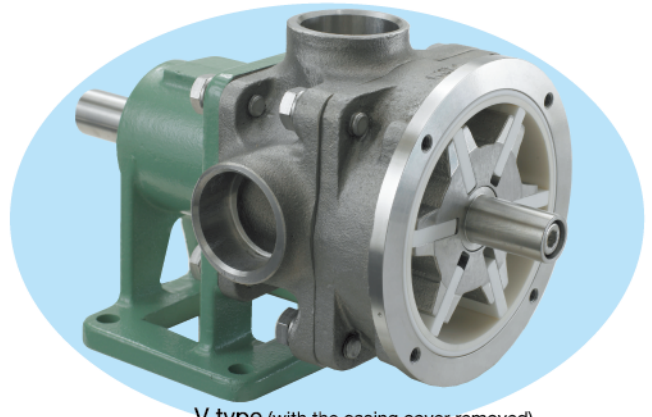

V type (with the casing cover removed)

V type

- Eliminates the drop of the performance due to vane abrasion.
- Just by changing the direction that the vanes are inserted, liquids can be transferred in either a clockwise or counterclockwise direction.

Pump. FUKKO's radial vane pump has a rotor on which the vanes are attached and the casing is eccentrically shaped. In addition, the vanes are moveable. When the rotor starts rotation in the arrow-indicated direction, the volume of the space created by two vanes and casing is enlarged, which sucks the liquid (fluid). With a half rotation, the volume begins to be reduced, thus discharges the sucked liquid. Suction and discharge are repeated by the vanes rotation. Even at a low-speed rotation, the liquid can be strongly and smoothly pumped.

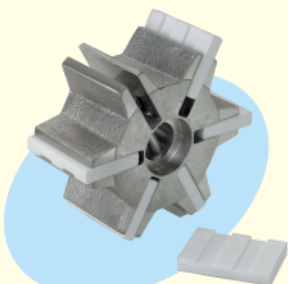

V type rotor and vane

Discharge start
(volume= large)

Discharge end
(volume =small)

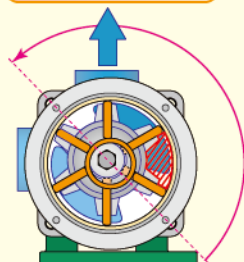

The volume begins to be reduced.

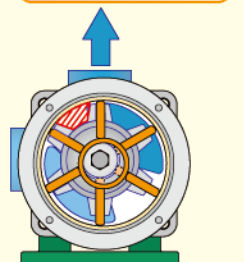

The volume is minimized.

V-type vane automatic pressure-adjusting mechanism (PATENT PENDING)

Conventional vane pumps have a drop in the flow rate and pressure because of the abrasion of the vanes. The V type vane automatic pressure-adjusting mechanism is a uniquely design that prevents such drops in the flow rate and pressure. This mechanism also lengthens the vane replacement cycle, and minimizes running costs.

V type vane automatic pressure adjusting mechanism

(The liquid pressure pushes up the vanes to compensate for abrasion)

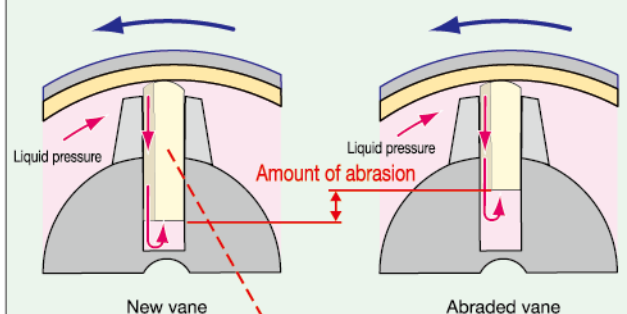

New vane

Abraded vane

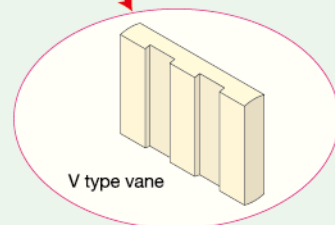

V type vane

Superbly meets the your needs and has had a

Upgraded durability and abrasion resistance

Its unique mechanism has the vanes are in contact with the inside of the casing, which almost completely prevents the vane from being either deformed or abraded. Further, the abrasion resistance has been surprisingly improved with adoption of the special-purpose vanes. The casing and liner inside (section that slides with the vanes) is press-fitted and sprayed with a ceramic coating. By employing experience with other unique technologies has greatly improved durability.

Handles highly abrasive liquids and slurry

●Ceramic press-fit casing

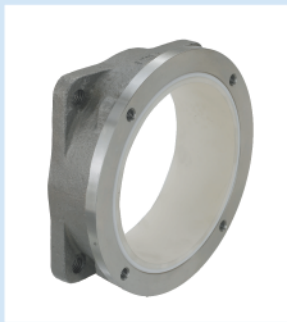

The ceramic used as the casing improves the chemical resistance and anti-corrosiveness as well as abrasion resistance. In addition, since the casing is not provided with a suction port or discharge port, ceramic cracking due to heat shock is greatly reduced and it provides stable performance even under severe working conditions.

●Ceramic treated rotor

Attaching a ceramic plate to the section of the rotor where the greatest load is applied to greatly improves the durability even for abrasive liquids.



●Special-purpose vane

Special-purpose vanes are also available for abrasive slurry.

Washing of the liquid contact section is possible in a short time



State when the casing is removed

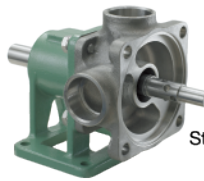

State where the port plate, rotor and vanes are removed

Since the inlet/outlet (port block) can be structurally separated from the casing, the casing can be removed with the transfer piping left alone as is (*). Thus, the liquid contact sections such as the rotor and vanes can be washed in a short time, facilitating daily maintenance.

●The special washing mechanism is also available.

Working conditions: According to the target fluid, a special-purpose washing mechanism can be adopted.

• Open cut (suction side)

Since the liquid does not remain inside the "stuffing" of the mechanical seal, the washing effect in the rotor gaps is great. Mainly, the method is used in the food industries.

Models:

R(V) - 40 N(NP), 40W (WP), 50P, 65P, 80P

RC (VC) - 40N (NP), 40W (WP), 50P, 65P, 80P

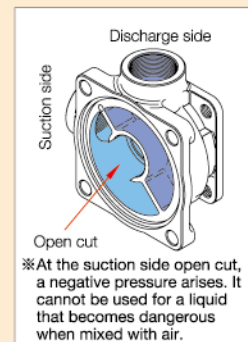

• Discharge hole drilling (discharge side)

The liquid in the "stuffing" box is expelled by the discharge pressure, and the pressure is increased in the box.

Self-flushing of the mechanical seal is provided.

Models:

R(V) - 40N(NP), 40W (WP), 50P, 65P, 80P

RC (VC) - 40N(NP), 40W(WP), 50P, 65P, 80P

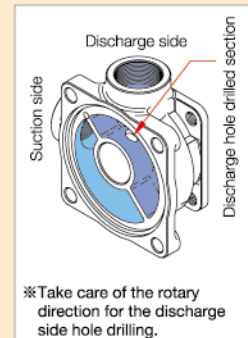

• Cut, hole drilling (discharge side)

Thrust out the liquid in the "stuffing" box by the discharge pressure and the pressure is increased in the box. Self-flushing of the mechanical seal is provided.

Models:

RV(V) - 20, 25 (P)

RV (V) - 20S, 25S (P)

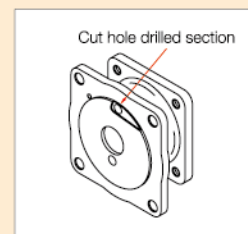

high level of user satisfaction for a long time.

To the very bottom of a drum

Since this volume-type pump has a unique mechanism, it provide complete self-suction that does not need any priming. It also handles gas mixtures (foamy). The NPSH value is so low that it is best suited for performing collection from a vacuum tank or from the very bottom of a drum.



It is tough enough to handle for solvents, high-temperature and high-viscosity solutions and slurry-mixed solutions.

The standard seal mechanism has a clutch. It supports a wide variety of solvents or high-viscosity solutions mixed with a solvent and slurry-mixed solutions. It is also possible to have it with an edge-sealing or fixing mechanism.

※The manufacturer will choose a shaft-sealing unit according to the working conditions.

For liquids that cannot be stirred: The discharge amount is variable.

The volume-type pump supports a low-speed operation (one revolution per minute for 100,000 CP) and can change the amounts being discharged with the help of a stepless speed reducer or inverter motor, which it can be used as a filling pump. It is the best-suited for transfer of liquids that cannot be stirred.

Supports maintaining temperature of the material during-pumping



As the necessity arises, attaching a front cover jacket can efficiently maintain the temperature of the material during-pumping.

Gentle operation

Since pumping is made smoothly without any mechanically unreasonable force applied, it provides a very gentle operation.

A variety of seals (shaft-sealing unit)

● Standard (sic/sic)

Model supported

Aperture: 20A to 50A

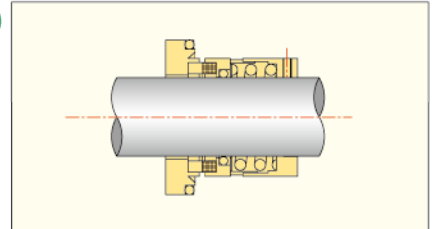

● Edge mechanism (ultra-hard/ultra-hard)

Models supported

All models

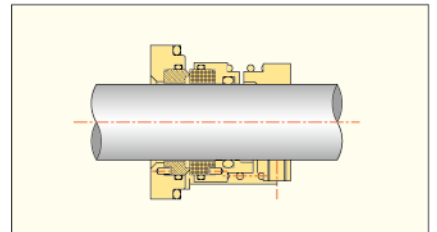

● Out mechanism (ultra-hard/ultra-hard)

Models supported

Aperture: 20A, 25A

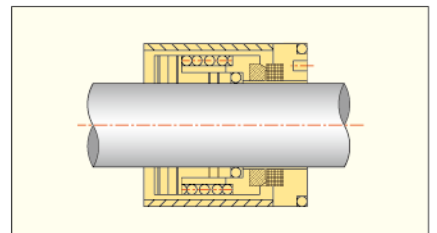

● Stationary mechanism (ultra-hard/ultra-hard)

Models supported

Aperture: 40A to 80A

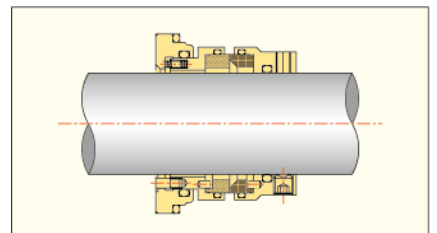

● Oil seal specification

Models supported

All models

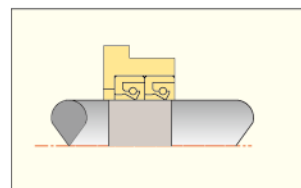

● O-ring specification

Models supported

All models

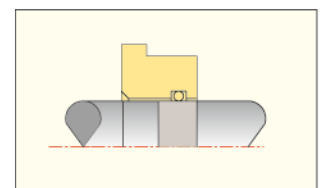

● Quenching specification

Models supported

All models

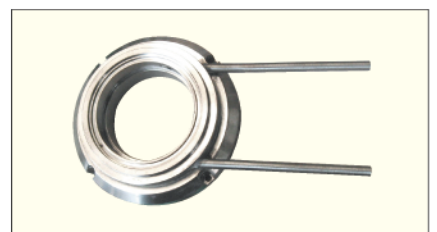

※Quenching is effective when a small amount of liquid leaking from the seal section is remains in the seal section and can damage it.

Flexibly Supports Various Needs and Ways of Installation

The several different ways of driving the FUKKO radial vane pump which aids in its flexibility in setups. According to the space and conditions beside the pump, there are a variety of ways it can be installed. A full lineup of small (20A) to large (80A) pumps is available.

Available with a V-belt driving full-face cover

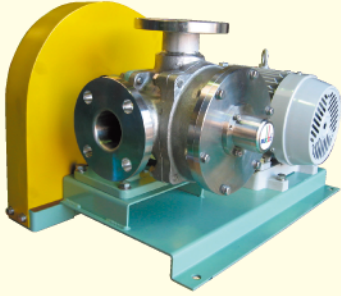

Stepless speed changer direct coupled type

Smoothly supports flow rate changes.

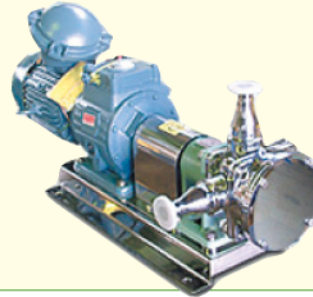

V-bet driving 2-step construction base

Allows installation even at a narrow space



Available with an SUS base motor full-face cover

This is best for cases when sanitary needs are very important

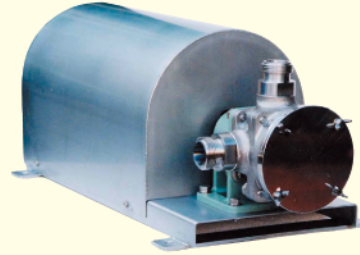

V-bet driving (with a carriage vehicle)



Speed reducer directly coupled

(Available with a carriage vehicle + inverter box)



Decelerator driving type

(SS base)



Speed changer driven

(SUS base)

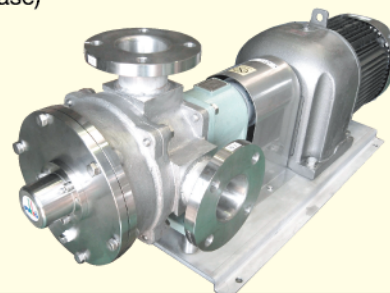

Outer dimensions

RV-20(S) RV-25(S)

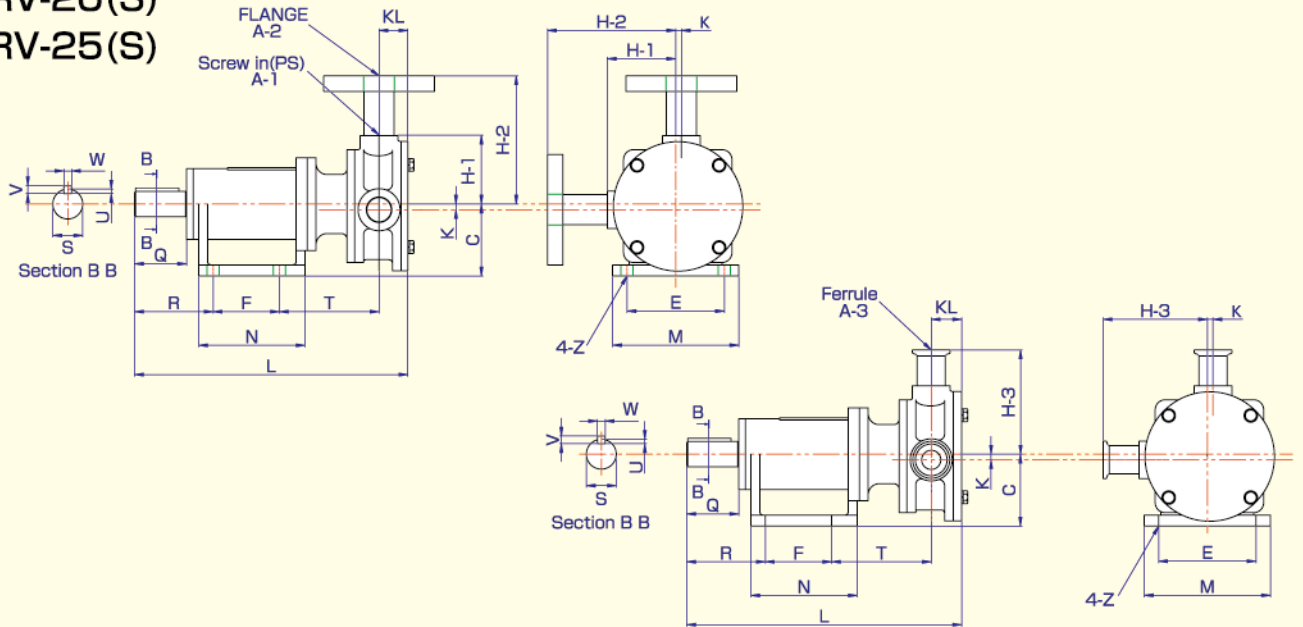

(Unit: mm)

MODEL	A-1	A-2	A-3	C	Q	R	S	U	V	W	F	N	L	E	M	H-1	H-2	H-3	K	KL	T	Z	Weight(kg)	A-1	A-2	A-3
RV-20(S)(F)(H2)	3/4"	20A	1S	65	47	71	φ23h7	4	7	7	60	96	249	88	114	62	116	94	5	28	90	φ11	7	8	7.5	
RV-25(S)(F)(H2)	1"	25A	1S	71	51	75	φ27h7	4	7	7	60	95	262	100	126	72	126	113	8	33	94	φ11	10	11.5	10.5	

V-20(S) V-25(S)

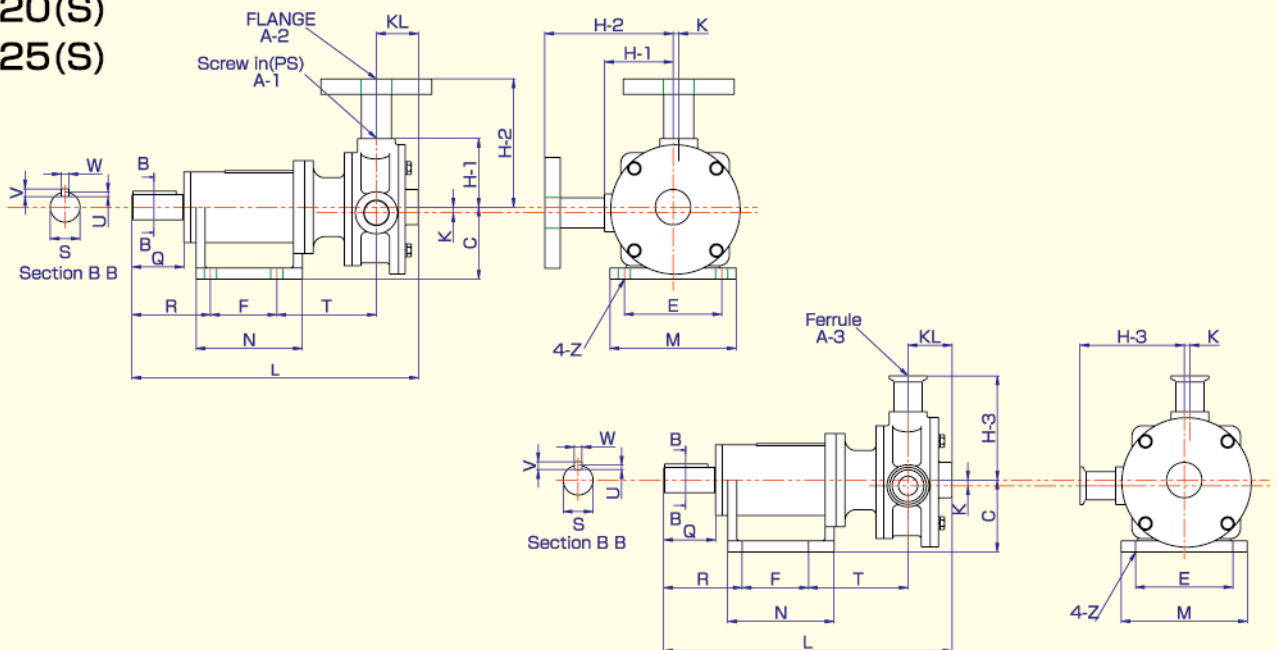

(Unit: mm)

MODEL	A-1	A-2	A-3	C	Q	R	S	U	V	W	F	N	L	E	M	H-1	H-2	H-3	K	KL	T	Z	Weight(kg)	A-1	A-2	A-3
V-20(S)(F)(H2)	3/4"	20A	1S	65	47	71	φ23h7	4	7	7	60	96	259	88	114	62	116	94	5	38	90	φ11	7	8	7.5	
V-25(S)(F)(H2)	1"	25A	1S	71	51	75	φ27h7	4	7	7	60	95	272	100	126	72	126	113	8	43	94	φ11	10	11.5	10.5	

Outer dimensions

RV-20(S)P RV-25(S)P

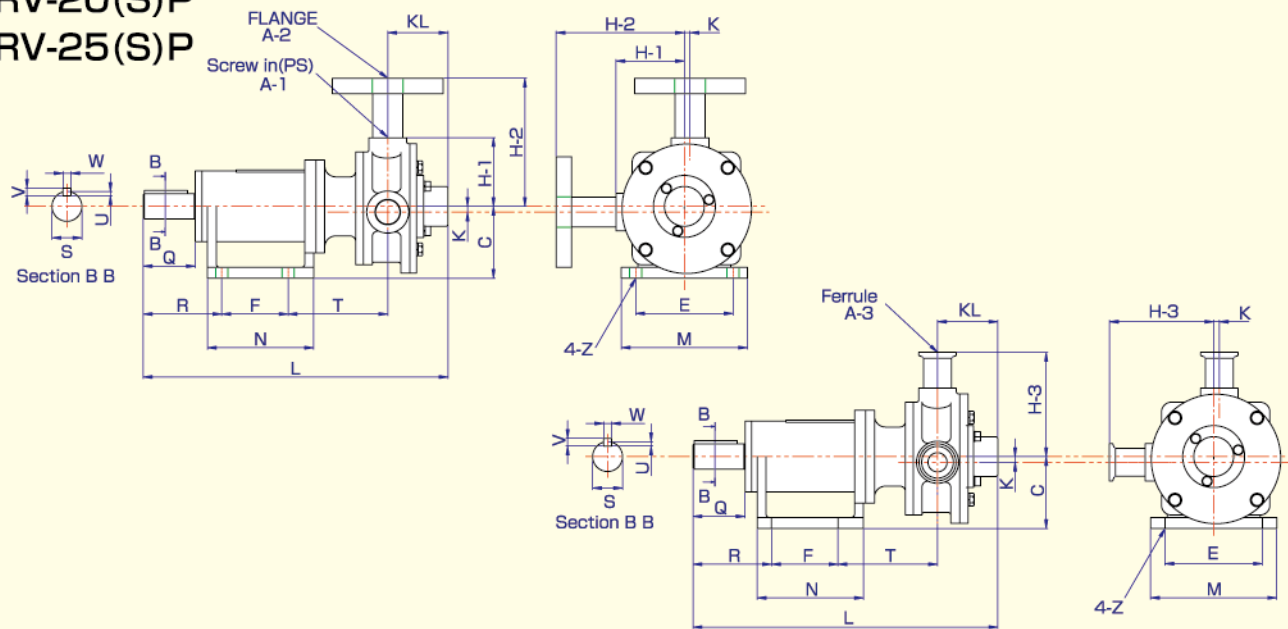

(Unit: mm)

MODEL	A-1	A-2	A-3	C	Q	R	S	U	V	W	F	N	L	E	M	H-1	H-2	H-3	K	KL	T	Z	Weight(kg)	A-1	A-2	A-3
RV-20(S)P(F)(H2)	3/4"	20A	1S	65	47	71	φ23h7	4	7	7	60	96	278	88	114	62	116	94	5	57	90	φ11	7.2	8.2	7.7	
RV-25(S)P(F)(H2)	1"	25A	1S	71	51	75	φ27h7	4	7	7	60	95	296	100	126	72	126	113	8	67	94	φ11	10.2	11.7	10.7	

V-20(S)P V-25(S)P

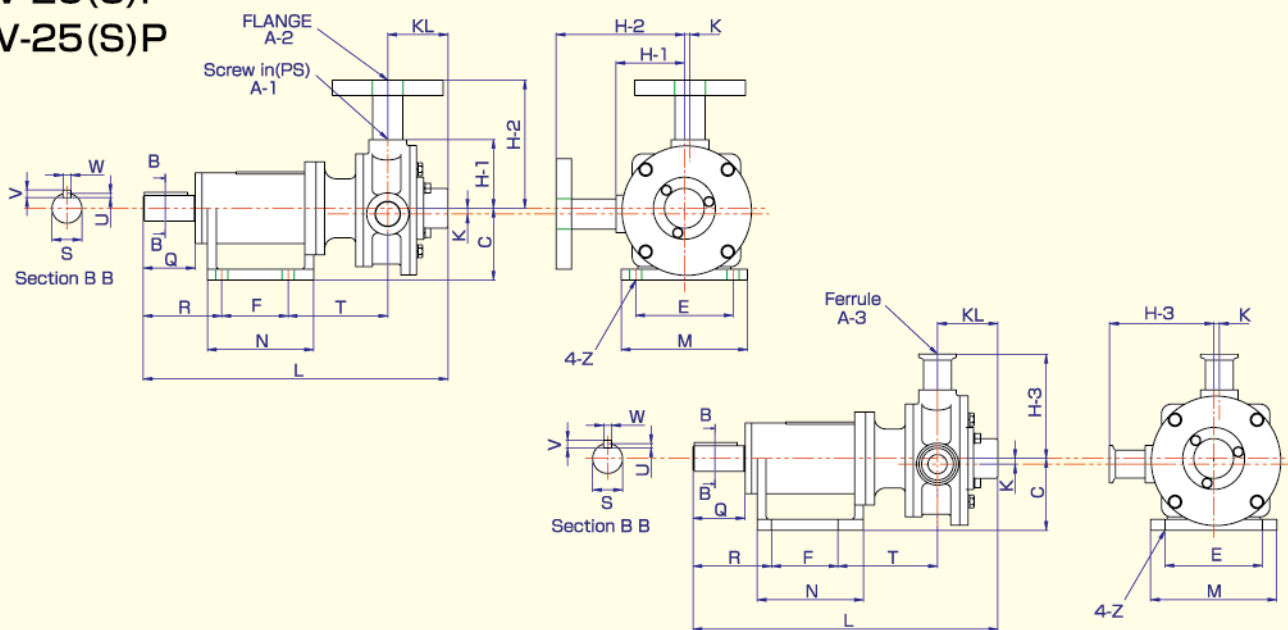

(Unit: mm)

MODEL	A-1	A-2	A-3	C	Q	R	S	U	V	W	F	N	L	E	M	H-1	H-2	H-3	K	KL	T	Z	Weight(kg)	A-1	A-2	AA-3
V-20(S)P(F)(H2)	3/4"	20A	1S	65	47	71	φ23h7	4	7	7	60	96	278	88	114	62	116	94	5	57	90	φ11	7.2	8.2	7.7	
V-25(S)P(F)(H2)	1"	25A	1S	71	51	75	φ27h7	4	7	7	60	95	296	100	126	72	126	113	8	67	94	φ11	10.2	11.7	10.7	

R(RC)-40N R(RC)-40W

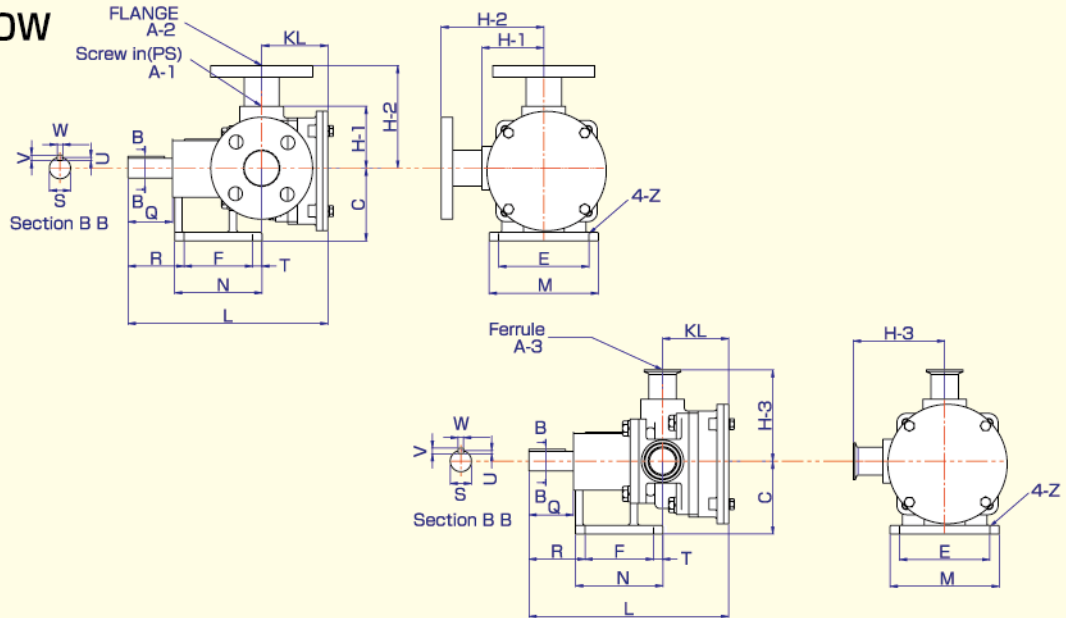

(Unit: mm)

MODEL	A-1	A-2	A-3	C	Q	R	S	U	V	W	F	N	L	E	M	H-1	H-2	H-3	K	KL	T	Z	Weight(kg)	A-1	A-2	A-3
R(RC)-40N(F)(H2)	1-1/2"	40A	1.5S	100	61	77	φ27h7	4	7	7	94	120	277	124	150	85	141	126	-	94	12	φ13	15	18.5	16	
R(RC)-40W(F)(H2)	1-1/2"	40A	1.5S	120	61	77	φ27h7	4	7	7	114	140	315	124	150	95	151	136	-	109	15	φ13	19	22.5	20	

V(VC)-40N V(VC)-40W

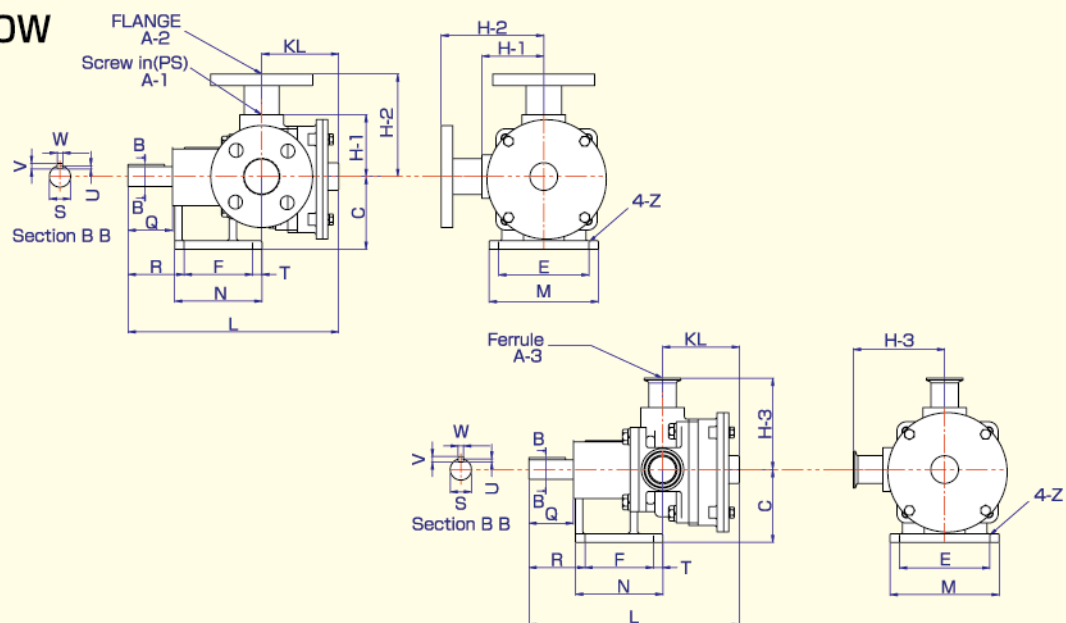

(Unit: mm)

MODEL	A-1	A-2	A-3	C	Q	R	S	U	V	W	F	N	L	E	M	H-1	H-2	H-3	K	KL	T	Z	Weight(kg)	A-1	A-2	A-3
V(VC)-40N(F)(H2)	1-1/2"	40A	1.5S	100	61	77	φ27h7	4	7	7	94	120	289	124	150	85	141	126	-	106	12	φ13	15	18.5	16	
V(VC)-40W(F)(H2)	1-1/2"	40A	1.5S	120	61	77	φ27h7	4	7	7	114	140	327	124	150	95	151	136	-	121	15	φ13	19	22.5	20	

Outer dimensions

R(RC)-40NP
R(RC)-40WP
R(RC)-50P
R(RC)-65P
R(RC)-80P

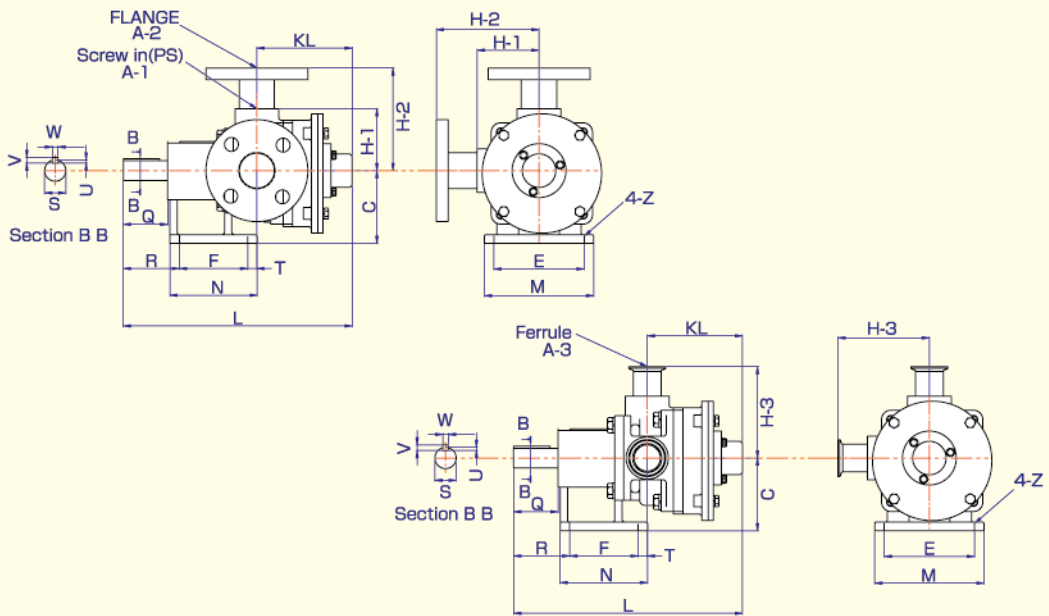

(Unit: mm)

MODEL	A-1	A-2	A-3	C	Q	R	S	U	V	W	F	N	L	E	M	H-1	H-2	H-3	K	KL	T	Z	Weight(kg)	A-1	A-2	A-3
R(RC)-40NP(F)(H2)	1-1/2"	40A	1.5S	100	61	77	φ27h7	4	7	7	94	120	314	124	150	85	141	126	-	131	12	φ13		15.5	19.4	17
R(RC)-40WP(F)(H2)	1-1/2"	40A	1.5S	120	61	77	φ27h7	4	7	7	114	140	360	124	150	95	151	136	-	154	15	φ13		19.6	23.5	21
R(RC)-50P(F)(H2)	2"	50A	2S	135	71	86	φ32h7	4	7	8	114	140	406	174	200	105	161	151	-	175	31	φ13		30.8	36.7	33
R(RC)-65P(F)(H)	-	65A	2.5S	150	76	96	φ40h7	5	8	12	168	208	520	164	204	-	188	161	-	219	37	φ14		-	73	68
R(RC)-80P(F)(H)	-	80A	3S	170	78	108	φ45h7	5.5	9	14	168	212	560	180	224	-	208	208	-	258	48	φ16	-	99	94	

V(VC)-40NP
V(VC)-40WP
V(VC)-50P
V(VC)-65P
V(VC)-80P

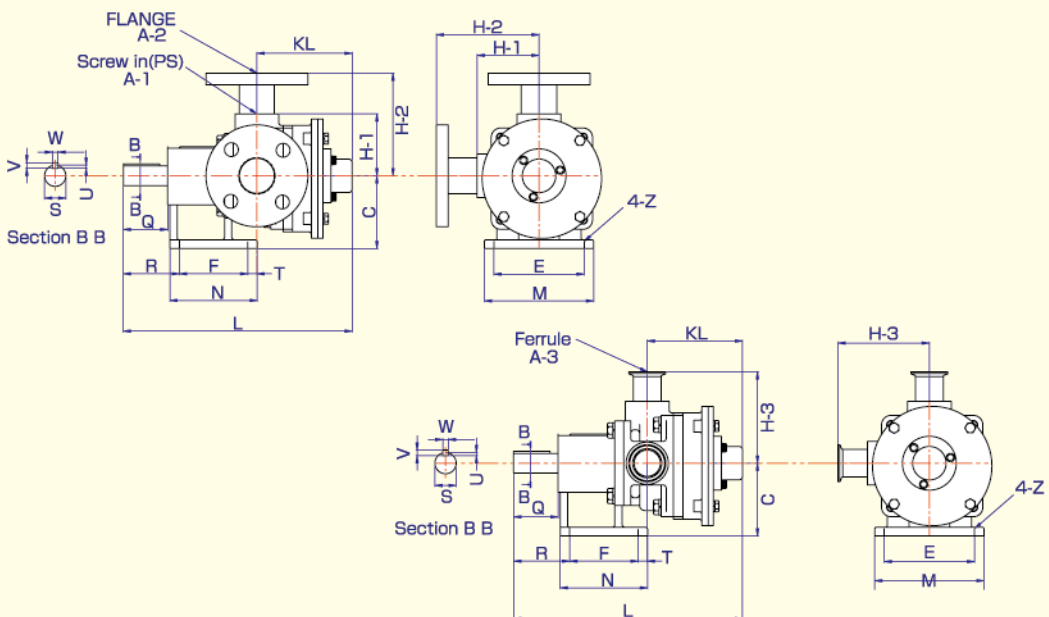

(Unit: mm)

MODEL	A-1	A-2	A-3	C	Q	R	S	U	V	W	F	N	L	E	M	H-1	H-2	H-3	K	KL	T	Z	Weight(kg)	A-1	A-2	A-3
V(VC)-40NP(F)(H2)	1-1/2"	40A	1.5S	100	61	77	φ27h7	4	7	7	94	120	314	124	150	85	141	126	-	131	12	φ13		15.5	19.4	17
V(VC)-40WP(F)(H2)	1-1/2"	40A	1.5S	120	61	77	φ27h7	4	7	7	114	140	360	124	150	95	151	136	-	154	15	φ13		19.6	23.5	21
V(VC)-50P(F)(H2)	2"	50A	2S	135	71	86	φ32h7	4	7	8	114	140	406	174	200	105	161	151	-	175	31	φ13		30.8	36.7	33
V(VC)-65P(F)(H)	-	65A	2.5S	150	76	96	φ40h7	5	8	12	168	208	520	164	204	-	188	161	-	219	37	φ14		-	73	68
V(VC)-80P(F)(H)	-	80A	3S	170	78	108	φ45h7	5.5	9	14	168	212	560	180	224	-	208	208	-	258	48	φ16	-	99	94	

Performance curves

R type

RV-20(S)(P)

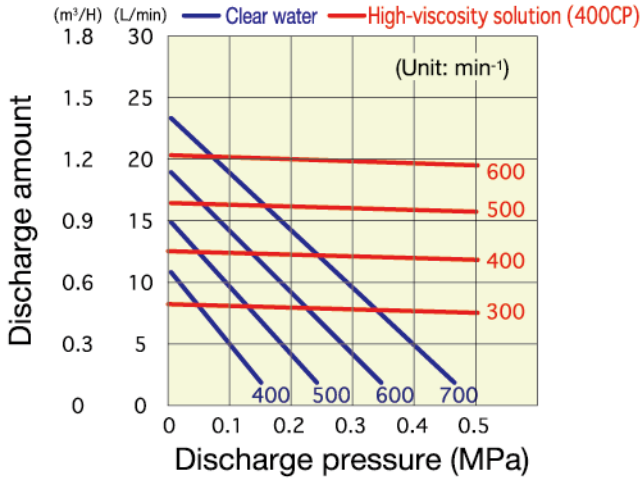

RV-25(S)(P)

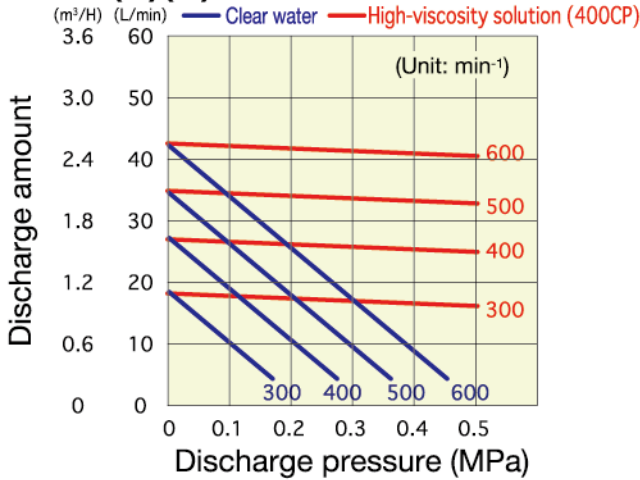

R(RC)-40N(NP)

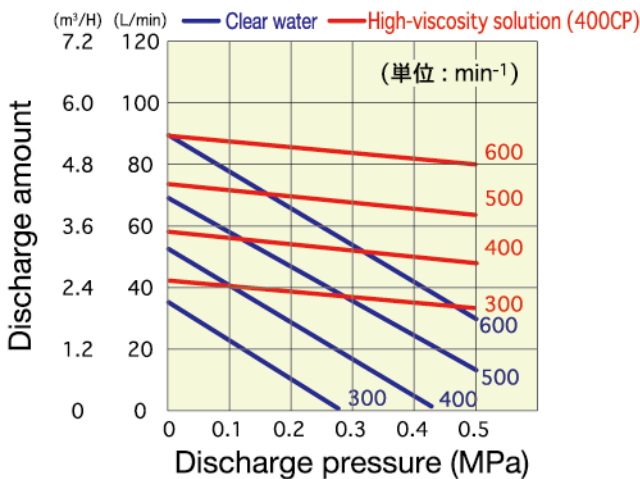

V type

V-20(S)(P)

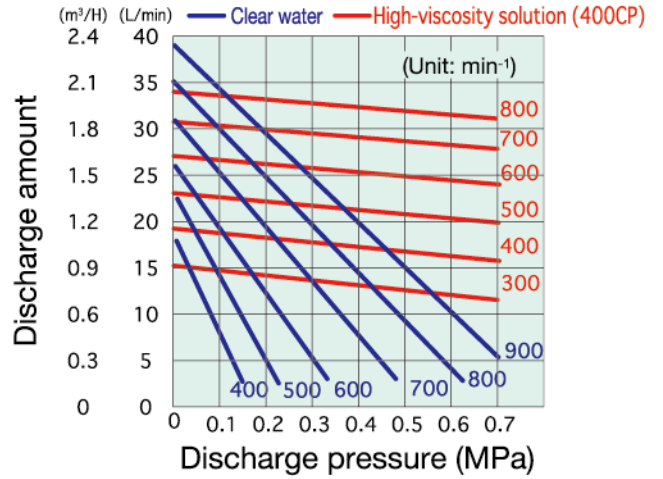

V-25(S)(P)

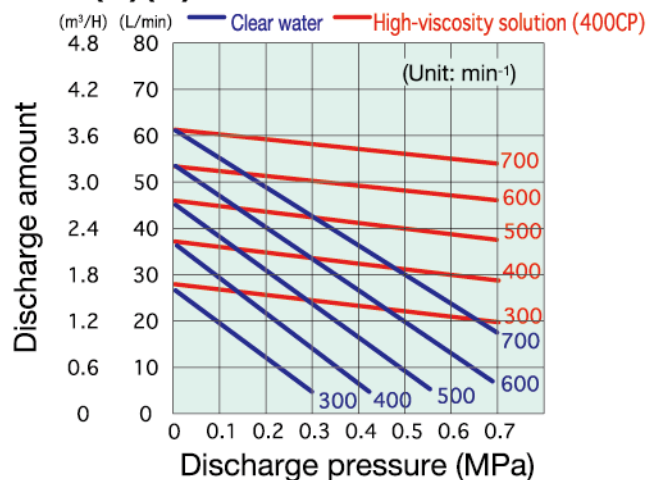

V(VC)-40N(NP)

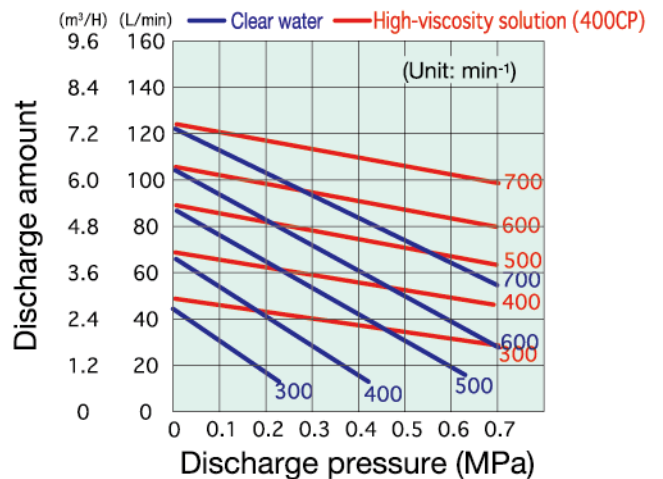

Performance curves

R type

R(RC)-40W(WP)

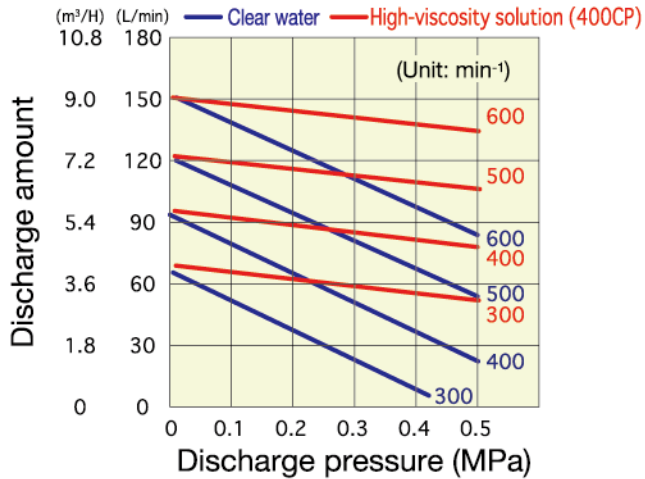

V type

V(VC)-40W(WP)

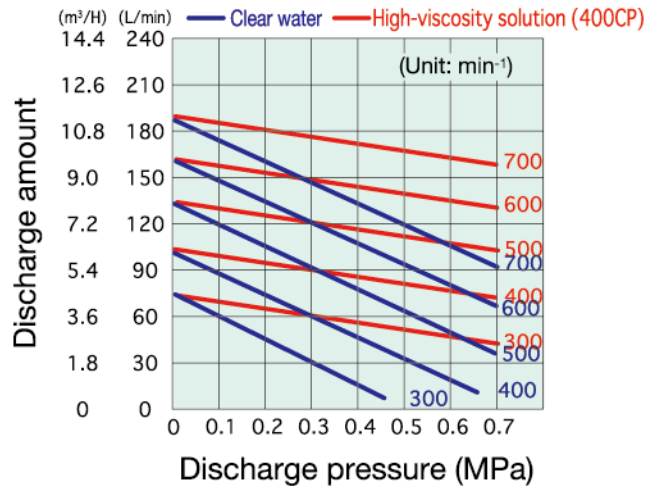

R(RC)-50P

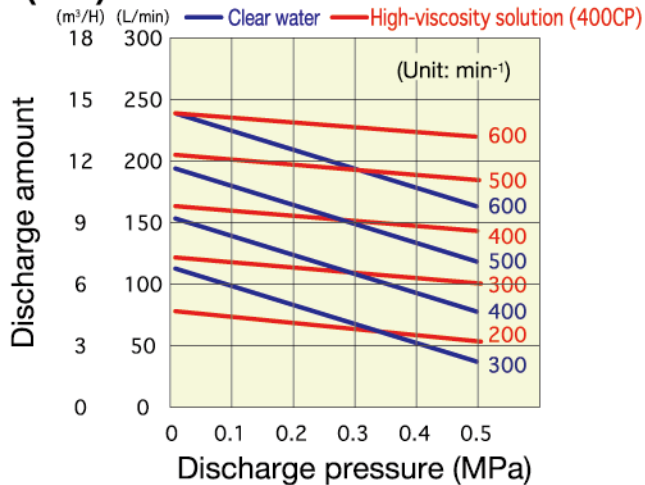

V(VC)-50P

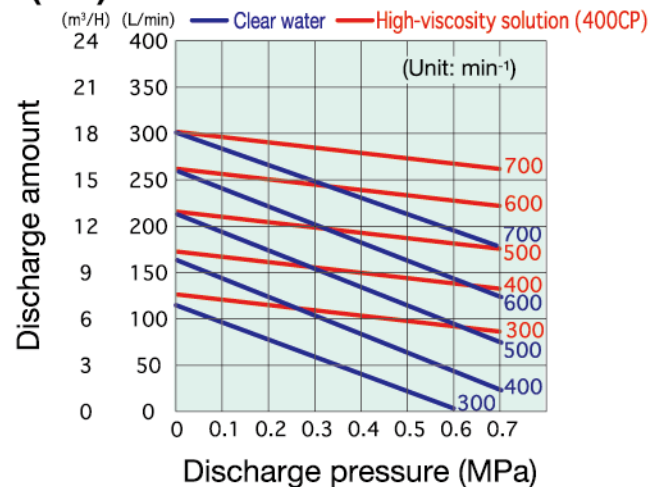

RC-65P

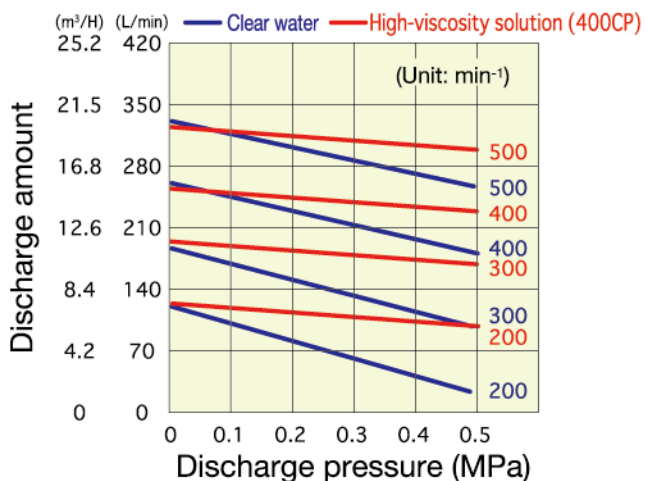

VC-65P

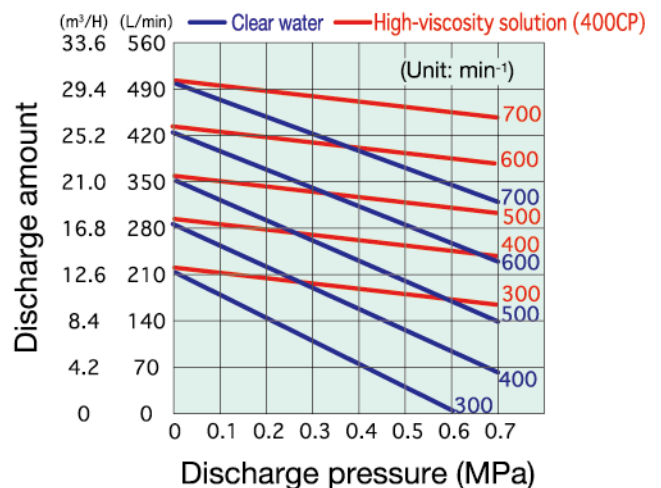

R type

RC-80P

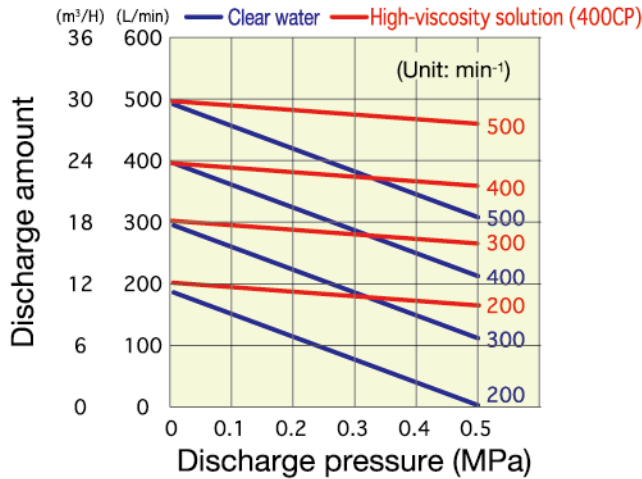

V type

VC-80P

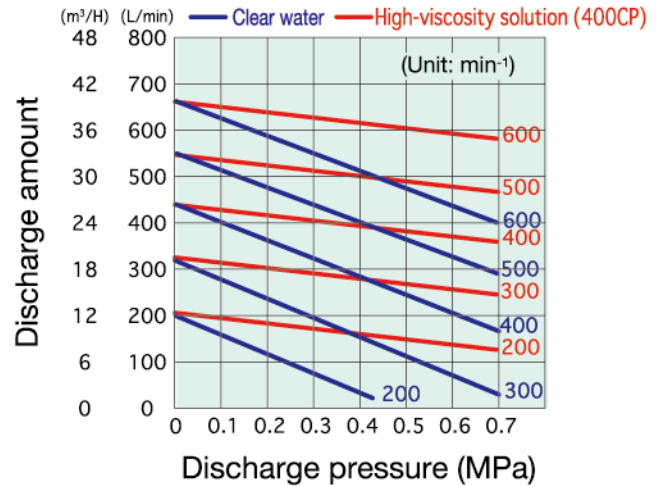

Model indications

The following indications differentiate the model of FUKKO radial vane pumps:

VC - 65 P E F Y J - MG A2
①
②
③
④
⑤
⑥
⑦
⑧
⑨

※ In each item, no indication given for the standard type (The pump model is indicated), and the indications are left-justified.

① : Pump model

R type → Casing and port block are integrated. (Aperture: 20,25)

R= standard

RC= The casing has a press-fit ceramic liner.

V type → V=standard

VC= The casing has a press-fit ceramic liner.

② : Pump Aperture

20, 25, 40, 50, 65, 80

③ : Discharge rate, discharge pressure

N → The discharge rate per revolution is low. (only for the Aperture 40)

W → The discharge rate per revolution is High (only for the Aperture 40.)

P → Discharge pressure: 0.3 MPa or more

S → Ceramic coated liner .. RV(V)-20, RV(V)-25

④ : Shaft sealing type

No-symbol → Standard, mechanical seal (sis/sic&SUS316)

U → Out mechanical seal---- RV(V)-20, RV(V)-25

E → Edge mechanical seal (ultra-hard/ultra-hard)

O → Other types (optional specifications)

⑤ : Connection type

No-symbol → Screw-in connection

F → Flange connection

D → IDF external screw connection

H → Ferule connection

H2 → Ferule welding

⑥ : O ring material (casing section, mechanical seal section)

No-symbol → Casing section = Vyton, Mechanical seal section = Vyton

Y → Casing section =NBR Mechanical seal section = Vyton

T → Casing section =Teflon, Mechanical seal section= kalrez + Teflon

⑦ : Other special specifications

J → Front jacket cover

Q → Quenching specifications

⑧ : Driving type

MB → V belt drive

MG → Decelerator

MV → Stepless speed reducer

⑨ : Other special specifications of the driving section

A → Available with an inverter

W → Available with a carriage vehicle

2 → 2-stage type

References

● Theoretical discharge rate for each model

Model	Discharge rate (L/rev)
RV-20(S) , V-20(S)	0.04
RV-25(S) , V-25(S)	0.09
R (RC) -40N , V(VC)-40N	0.186
R (RC) -40W , V(VC)-40W	0.296
R (RC) -50P , V(VC)- 50P	0.466
RC-65P , VC-65P	0.756
RC-80P , VC-80P	1.202

● Viscosity reference table

Fluid names	Temperature (°C)	Viscosity (x100 mPa-s)
Ketchup	24	18
Mayonnaise	23	80
Condensed milk	21,5	20
Honey	21	19
Sweet corn (soup stock)	22	22
Laver boiled down in soy	23,5	130
Chocolate topping	21	380
Toothpaste	20,5	300
Silver cream	23	180
Pomade	21	450
Glue	21,5	290
Boot polish	20	120
Caster beans	20	7
Enamel	19,5	45

● Correction coefficient due to viscosity

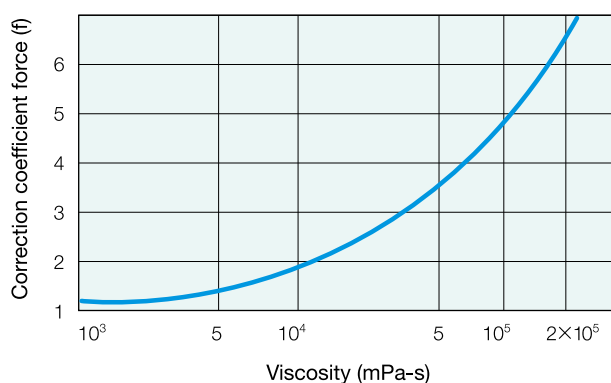

● Critical RPMs due to viscosity

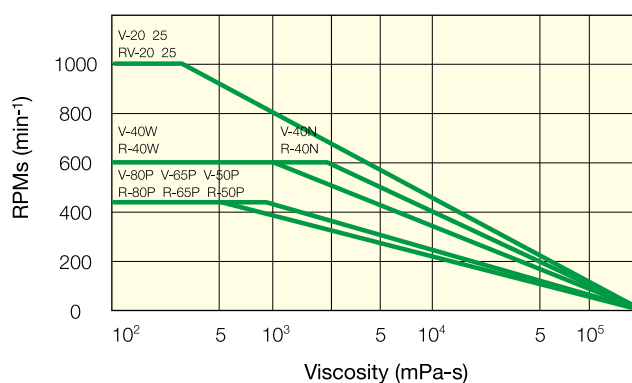

● Calculation of motor horsepower

$$\frac{P \times Q \times N}{6.12 \times 10^2} \times f \times 1.5 = \text{Required output (kW)}$$

P : Total output <Max.> (MPa)

Q : Theoretical discharge rate per pump revolution (L/rev)

N : No. of revolutions (min⁻¹)

Sample calculation

Pump used = R-40N Liquid to send = 5,000 mPa-s

P = 0.3 MPa

Q = 0.186L/rev

N = 400 min⁻¹

In the above case,

$$0.3 \times 10 \times 0.186 \times 400 / 612 \times 1.5 \times 1.5 = 0.82 \text{ kW} = (\text{approx.}) 1.5 \text{ kW}$$

The required horsepower is 1.5 kW

※The above material differs depending on various conditions. Use this as a reference.

If you have any inquiries:

We would appreciate your help if you fill in the following information sheet before you make an inquiry, for example when looking for an estimate.
(Please fill in the data to the extent of your knowledge.)

Transferred substances	Material			
	State of the material	Liquid, cake-like materials, Solid with some fluidity.		
	Temperature	Common use	°C/Maximum	°C
	Cleaning	None	Clean (°C)	(Hot water CIP SIP vapor)
	Relative density	(at °C)		
	Viscosity	mPa·s(at °C)		
	Solid mixture	None	Mixed (Properties Granularity Rate of mixture %)	
	Corrosive	No	Yes	
Pump specification	Discharge volume	L/min.	m ³ /Hr	
	Discharge Intake	m	Mpa	
	pressure	Push (+)	m	Suction (-)
Motor specification	Power supply	V	Hz	Indoor/Outdoors
	Type	TEFC, Explosion proof safety increased, Explosion proof		
	Driving method	V belt, Reduction gears, Continuously variable transmission, Inverter motor		
Connection duct	Intake duct aperture			
	Discharge duct aperture			
Piping drawing				



FUKKO KINZOKU Industry Co., Ltd.

Head office, Factory: 2-33, Fukiya-cho, Wakayama City, Wakayama Pref., 640-8324 Japan

TEL. +81-73-424-8155 FAX. +81-73-426-0710

Tokyo office: TEL. +81-3-3553-0351 FAX. +81-3-3553-0352

Kokawa factory: TEL. +81-736-73-6161 FAX. +81-736-73-7110

URL: <https://www.fukko.com/>
E-mail: fukkopump@fukko.com



 **Safety precautions**

Carefully read the manual before use.
Use this product properly.

*Information in this brochure may be subject to change without notice.

*Please do not copy the information in this brochure without prior permission.



FUKKO KINZOKU Industry Co., Ltd.

Head office and factory: 2-33 Fukiyacho, Wakayama City, Wakayama Pref. 640-8324

PHONE +81-73-424-8155 / FAX +81-73-426-0710

Tokyo office: 3F Shiobe Bldg., 4-9-6 Hacchobori, Chuo Ward, Tokyo 104-0032

PHONE +81-3-3553-0351 / FAX +81-3-3553-0352

Kokawa Factory: PHONE +81-736-73-6161 / FAX +81-736-73-7110

URL: <https://www.fukko.com/>
E-mail: fukkopump@fukko.com

ISO 9001:2015

Certification:
Head office
Tokyo office



2208-WEB